

Axial Fan Owner's Manual

Model :
P-21AR, P-26AR

(115V 60HZ)

Read and save these instructions before use



Intertek

www.xpower.com | 1-(855)-855-8868 | info@xpower.com

Index: NA-1-A6
Edition: 2.1.Final

Safety Instructions

WARNING - READ AND SAVE THIS INSTRUCTIONS BEFORE USING THIS PRODUCT.

The user of electrical products may create hazards that include, but are not limited to injury, fire, electrical shock. Failure to follow these instructions may damage and/or impair its operation and void the warranty.

- Before operating, remove all packaging material and check for any damage that may have occurred during shipping or any missing items.
- Check household power supply to ensure it matches the appliance's specification.
- **DO NOT** operate any fan with a damaged cord or plug. Discard fan or return it to an authorized service facility for examination and/or repair.
- Use only on GFCI protected receptacles. Please contact a qualified electrician for verification and / or installation of a GFCI receptacle if necessary.
- **DO NOT** run cord under carpeting. **DO NOT** cover cord with throw rugs, runners, or similar coverings. **DO NOT** route cord under furniture or appliances. Arrange cord away from traffic area and where it will not be tripped over.
- To reduce the risk of fire or electric shock, do not use this fan with any solid-state speed control device.
- **DO NOT** touch this appliance or the plug with wet hands or while standing in water.
- **DO NOT** operate the appliance in any pooled water.
- **DO NOT** use the product in areas where gasoline, paint or other flammable goods and objects are used or stored.
- **DO NOT** insert or allow objects to enter any ventilation or exhaust opening as this may damage the appliance and void the warranty.
- **DO NOT** cover the air inlet or outlet on the appliance.
- **DO NOT** direct the air flow at human faces or bodies.
- **DO NOT** allow children to play with this appliance.
- **AUTOMATICALLY OPERATED DEVICE** – To reduce the risk of injury, disconnect from power supply before servicing.
- Remove the power cord from the electrical receptacle by grasping and pulling on the power cord plug-end only, **DO NOT** pull the cord directly.
- **DO NOT** attempt to repair or adjust any electrical or mechanical functions of this appliance, as this may cause danger and void the warranty.
- If the appliance is damaged or it malfunctions, **DO NOT** continue to use it. Unplug the product from the electrical outlet. Refer to troubleshooting guide or contact XPOWER.
- Store in a dry area, away from exposure to sunlight, extreme temperature and humidity, or other extreme environments, when not in use.
- **DO NOT** stack more than six units of this appliance.
- An electronic instruction manual can be obtained through manufacturer's website www.xpower.com.

Items Included

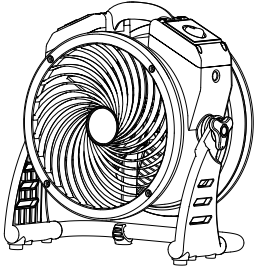

- Axial Fan x 1



- Owner's Manual x 1

Parts Description

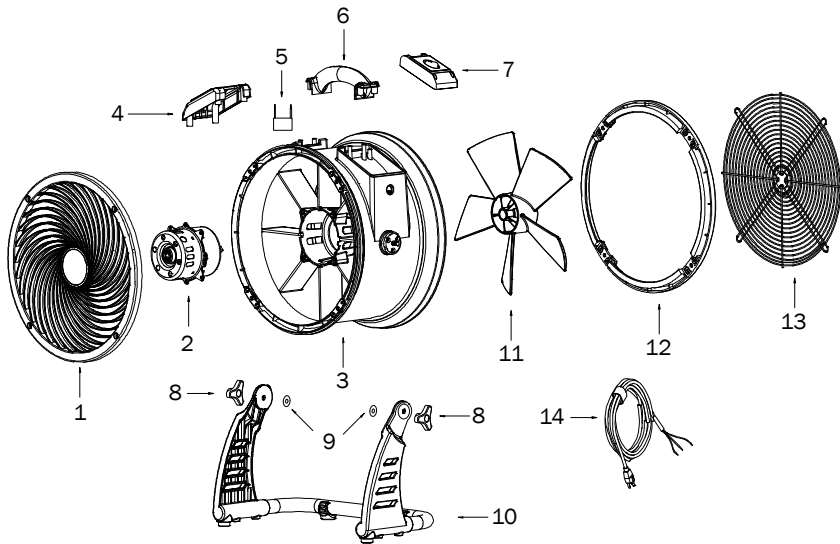

- | | | |
|--------------------------------------|--------------------|------------------------|
| (1) Front Grille Cover | (5) Capacitor | (10) Rack |
| (2) Motor | (6) Housing Handle | (11) Fan |
| (3) Housing | (7) Switch Plate | (12) Rear End Cover |
| (4) Additional Electrical Receptacle | (8) Rack Handle | (13) Rear Grille Cover |
| | (9) Rubber Washer | (14) Power Cord |

Axial Fan Introduction

- XPOWER Axial Fans are designed to offer efficient air circulation and ventilation with its high and long-distance focused airflow.
- It's perfect for air circulation and ventilation in janitorial/ sanitation jobs, water damage restoration and more.

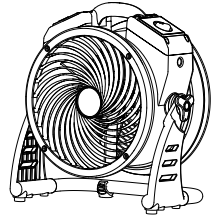

Operation Guide

Switch Plate

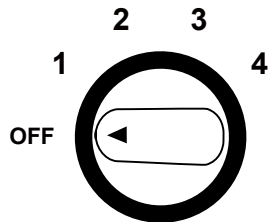

Speed Control

Speed Switch

- Turn to **“OFF”** position to switch the Axial Fan OFF. Turn to any speed position to switch the Axial Fan ON.
- Turn clockwise to set the desired speed. There are 4 speeds from: **4, 3, 2, 1**. **“4”** is the highest speed and **“1”** is the lowest speed .

Operation Guide (Continued)

Additional Electrical Receptacle (Daisy Chain)

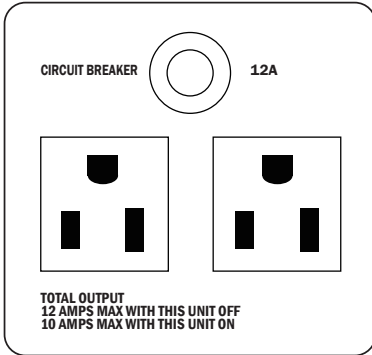

- Other appliances can be plugged in the additional electrical receptacles and work whether the Axial Fan is on or off. However, the total amperage must be lower than the amperage instructed. Different models may have varying instructions.
- If the Axial Fan or the plugged in appliance stops working, press the **RESET BUTTON** to reset the circuit.

Adjust Operation Position

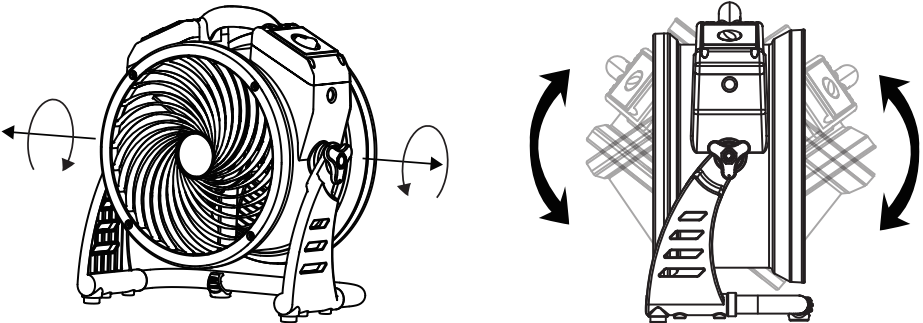

- The Axial Fan features 360° Rotation. Tilt the Axial Fan to desired angle and screw on rack handles to secure the fan's position.

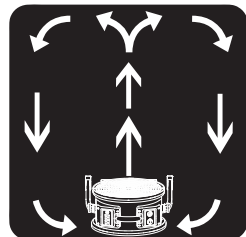
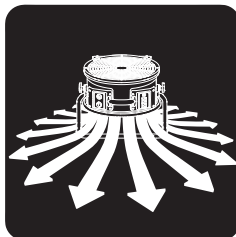
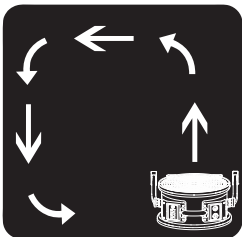

Operation Guide (Continued)

Transportation

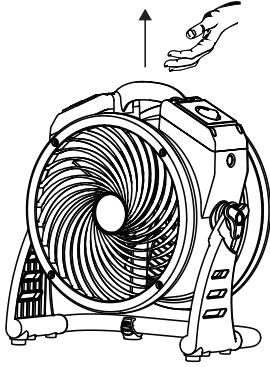

Lift with Handle

- Lift the Axial Fan with the handle on the top.

User Maintenance Instructions

Frequent maintenance is recommended on this appliance. Failure to follow the maintenance instructions may cause failure of the appliance and void the warranty.

- When not in use, unplug and store the appliance in a dry and cool indoor place. Make sure it's out of reach of children.
- Before performing any maintenance or cleaning, always disconnect the Axial Fan from its power source.
- Use a damp cloth to wipe the surface of the housing. Do not clean the unit with water directly.
- Check if the grille covers are clean. Remove dirt or any other objects that could block the air inlet and air outlet.

User Maintenance Instructions (Continued)

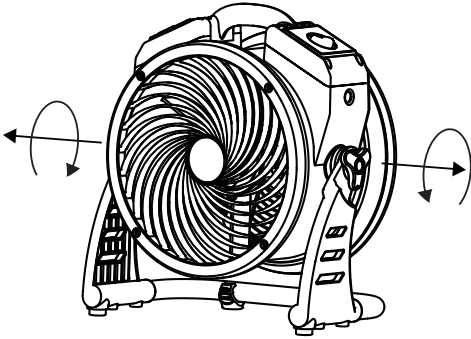

Fasten the Rack Handles

- To prevent possible injury, when you finish using this appliance, please position the Axial Fan **UPRIGHT**.
- Fasten the rack handle to lock the position of the Axial Fan.

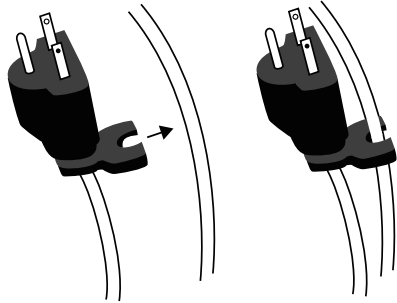
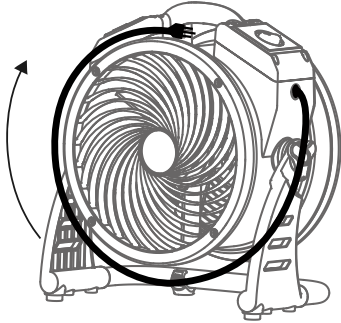

Organize the Power Cord

- Wrap the power cord around the housing.
- Clip the cord to the cord clip on the plug shown above.

User Maintenance Instructions (Continued)

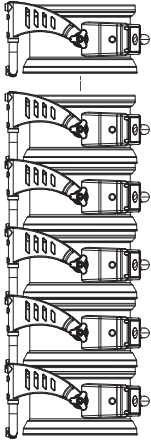

Stack Multiple Units

- Stack the Axial Fans on the sides. Align the air inlets of both Axial Fans.

! WARNING

- Do not stack more than six units of this appliance.
- Stacking function is not secure during transportation.

Troubleshooting Guide

PROBLEM	POSSIBLE CAUSE	SOLUTION
Axial fan does not start	No electricity.	Check for power supply.
	The power cord is not properly plugged in.	Remove and reconnect the power cord.
	The circuit breaker on the additional electrical receptacle (Daisy chain) jumps.	Remove all appliance on the additional electrical receptacle and press "Reset".
Unit runs but the speed is abnormal	Air inlet or air outlet is blocked.	Remove blockage.

If troubleshooting does not resolve your problem, please contact XPOWER or other parties authorized by XPOWER for further instructions.

Technical Specification

MODEL NUMBER	P-21AR	P-26AR
Voltage/ Frequency	115 V~60 Hz	
Amperage	0.6 A	1.0 A
Rated Airflow	1100 CFM	1300 CFM
Speed Control	4 Speeds	
Additional Electrical Receptacles (Daisy Chain)	Yes	
Cord Length	10 ft. / 3.0 m	
Housing	PP	
Unit Dimension (L) x (W) x (H)	16.1 x 8.9 x 14.2 in. / 41.0 x 22.5 x 36.0 cm	17.3 x 8.9 x 15.4 in./ 44.0 x 22.5 x 39.0 cm
Unit Weight	10.4 lbs. / 4.7 kg	11.7 lbs. / 5.3 kg
Safety Certification	ETL / C-ETL	

If your product(s) is not listed above, please visit www.xpower.com for more information.

XPOWER Limited Warranty (USA)

1 YEAR LIMITED WARRANTY

XPOWER-branded products purchased in the U.S. from authorized distributors include a 1-year limited warranty. Contact XPOWER to confirm warranty information about your product(s).

This limited warranty covers defects in materials and workmanship in your XPOWER-branded products, purchased in the **U.S. ONLY**. Local warranty policy (if any) in your country will cover products purchased outside the U.S.

IMPORTANT:

- (1) Please finish the online warranty registration before usage. Visit www.xpower.com/service-support/warranty-registration.
- (2) This Limited Warranty applies with its own timeliness. Contact XPOWER or visit www.xpower.com for more information.

Items mentioned but not limited to below are not covered by warranty:

- (1) Power cord, filters or any other components considered as a “consumable parts” by XPOWER.
- (2) Normal wear and tear.
- (3) Problems that result, directly or indirectly, at XPOWER’s sole discretion, from:
 - (3.1) External causes such as accident, abuse, misuse or problems with electrical power supply.
 - (3.2) Disassembling, servicing or modification not authorized by XPOWER.
 - (3.3) Usage that is not accordant with product instructions stated in Owner’s Manual.
 - (3.4) Failure to follow the product instructions or lack of necessary maintenance stated in Owner’s Manual.

Before contacting XPOWER, please try one or more of the following:

- (1) Consult this Owner’s Manual and follow the instructions of troubleshooting guide.
- (2) Access www.xpower.com for more advice and information that could be helpful to address your problems.

If you need additional assistance from XPOWER, please:

- (1) Email info@xpower.com.
- (2) Call XPOWER U.S. Customer Service Department at **855-855-8868** or other numbers provided on www.xpower.com.
- (3) Visit XPOWER U.S. Head Office at [240 Clary Ave., San Gabriel, CA 91776](http://www.xpower.com) or the most current address provided on www.xpower.com.

Please also have your original proof of purchase and the serial number(s) of your product(s) ready when you contact XPOWER.

XPOWER Limited Warranty (USA)

If you are instructed to return the unit for service or replacement, please:

- (1) Request a RMA (Return-Merchandise-Authorization) number.
- (2) Use the original or an equivalent packaging, prepay shipping charges at your own expense to the address provided by XPOWER, with the RMA number on the shipping label or the packaging.
- (3) Include all the original parts and components.

XPOWER will inspect, assess and advise the repairs needed and applicable cost, if any. For products under warranty, we will pay to ship the repaired or replaced product(s) to you if you use an address within the Contiguous United States. Otherwise, we will ship the product(s) to you at your own expense.



XPOWER Manufacture, INC.

240 Clary Avenue

San Gabriel, CA 91776 USA

www.xpower.com | 1-(855)-855-8868 | info@xpower.com

Read and save these instructions before use